

electrical

STEP-BY-STEP SPECIFICATION – 8-WIRE ELECTRICAL SYSTEM

Step 1 Determine the location of the source power entering the Panel Run.

1. At the base of the Panel.
 - (a) Use EVE8FR1 Reversible Floor Power Entry (default to EVE8FR1).
 - (b) Select the Panel to which the Floor Power Entry will be attached. This Panel requires an EVEPD Power Distribution Housing.
 - (c) Select the side of the Panel and the receptacle outlet to which the Floor Power Entry is to be attached.
2. From the ceiling.
 - (a) Use EVE8EC1 Ceiling Power Entry.
 - (b) Select the post through which to feed the Ceiling Power Entry.
 - (c) One Panel adjacent to the selected post requires an EVEPD Power Distribution Housing.
 - (d) Attach Ceiling Power entry to the nearest end of the Power Distribution Housing.

Step 2 Determine which Panels are to be powered.

1. Use EVE8PD Power Distribution Housing that corresponds with the width of the Panel.

Step 3 Connect power to the powered Panels.

1. Use EVE8CP16 Jumper Cable between two adjacent powered Panels, separated by an Inline Connector.
2. Use EVE8CP18 Jumper Cable between two adjacent powered Panels separated by a post.
3. Use EVE8CP Pass-Through Cables to connect powered Panels that are separated by one or more non-powered Panels (maximum distance between the powered Panels is 16 feet).
 - (a) The length of the Pass-Through Cable is calculated by adding together the widths of the non-powered Panels (that separate the two powered Panels) and applying an additional 16" to the total. (EVE8PD Power Distribution Housing is positioned 8" in from the ends of the powered Panel.)
 - (b) An additional 3" must be added to the Pass-Through Cable for each post that the cable passes through.
4. From the price list, select the EVE8CP Pass-Through Cable that matches the calculated length. If the length is between listed sizes, use the next size up.

Step 4 Determine the location and circuitry of the receptacles.

1. Each powered Panel has four (4) potential locations for EVE8RD Duplex Receptacles – 2 per side. (Exception: 24" wide Panel has only two potential locations – 1 per side, 18" wide Panel has no locations for receptacles.)
2. At each receptacle location there is a choice of four circuit options. Select a circuit option for each location. Circuits one & two are utility circuits; circuits A & B are dedicated circuits.

BELTLINE TIPS:

DO - use a 17" long Mesh Beltline Jumper when making 90 degree turns in the Beltline raceways only.

DO NOT - use a 20" long Metal Flex Jumper when attempting to make 90 degree turns in the Beltline Raceways. The end connector is too long to make the turn.

DO - use a 20" long Metal Flex Jumper when traveling through a Beltline Post, in a straight line only.

DO NOT - use a 17" long Mesh Beltline Jumper Traveling through a Beltline Post, in a straight line only. The Jumper is too short to make the connection.

EVOLVE'S MODIFIED 8-WIRE ELECTRICAL SYSTEM

Evolve has modified its 8-Wire Electrical System to stay abreast of changing industry standards.

Evolve's electrical system allows for the integration of the commonly required "2+2" configuration (2 utility circuits, 2 dedicated circuits) found in the source power of most of today's North American buildings.

This system is rated for connection to:

1. A grounded 120/240V, single phase, 20 A, 60Hz
2. A 120/208V, 3 phase, 20 A, 60Hz branch circuit

EQUIPMENT AMPERAGE

Calculator	0.25
Electric Eraser	0.50
Pencil Sharpener	1.00
Radio	0.05
Paper Shredder.....	4.40 - 13.00
Electric Typewriter	1.20
Personal Computer.....	2.00 - 4.00
Video Display Terminal	0.08
Draft / Letter Quality Printer.....	1.20 - 3.00

Data/Comm

Evolve's duplex receptacle openings will now conform to the ANSI/TIA/EIA Furniture Opening Standard of 1.38 +/- .035 x 2.71 +/- .04. There will no longer be the need to use adapter plates to reduce the size of Evolve's raceway opening, or to use Evolve dedicated data plates for data/comm terminations.

Transition

A transition cable is available to connect the previous electrical system prior to April 1, 2005 to the current system when adding Panels to an existing installation. Also, new raceway covers with the smaller openings can be provided and applied to existing Panels when retrofitted with new electrics.

Fan.....	1.00
Heater.....	8.50 - 12.50
Coffee Pot.....	15.00
Task Light	1.00
Slide Projector.....	2.00 - 6.00
Laser Printer	5.00 - 8.00
Processor / Disk Unit	1.00 - 10.00
Desk Top Plotter	1.50

Some equipment, such as large copiers, printers, plotters, heaters and coffee makers may occupy most of the circuit capacity. It is recommended that such devices be supplied with the power directly from the wall or building receptacle.



WIRING SCHEMATIC

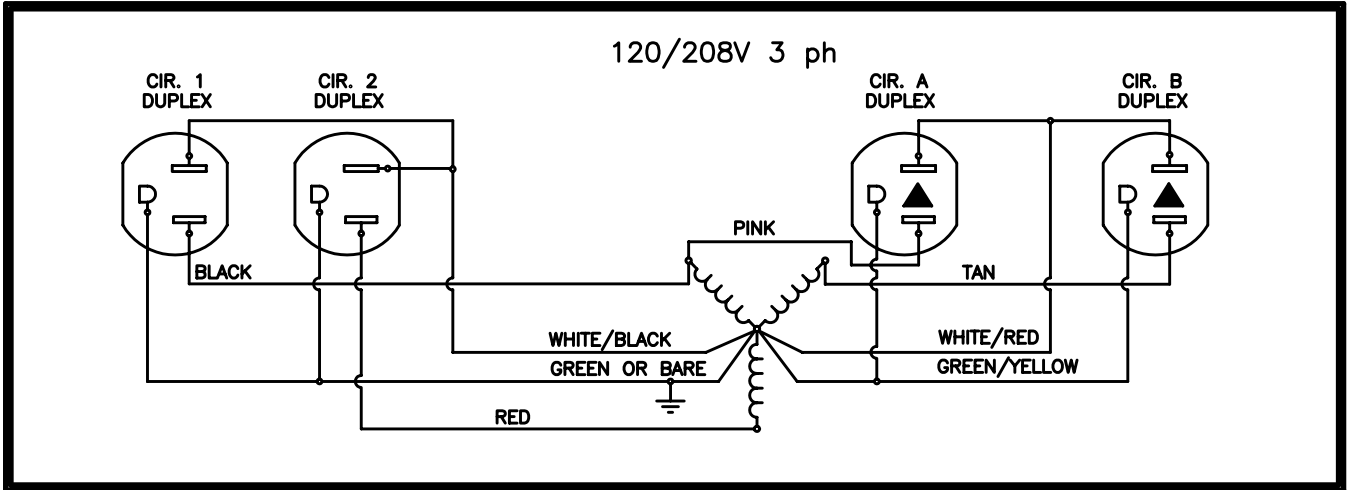
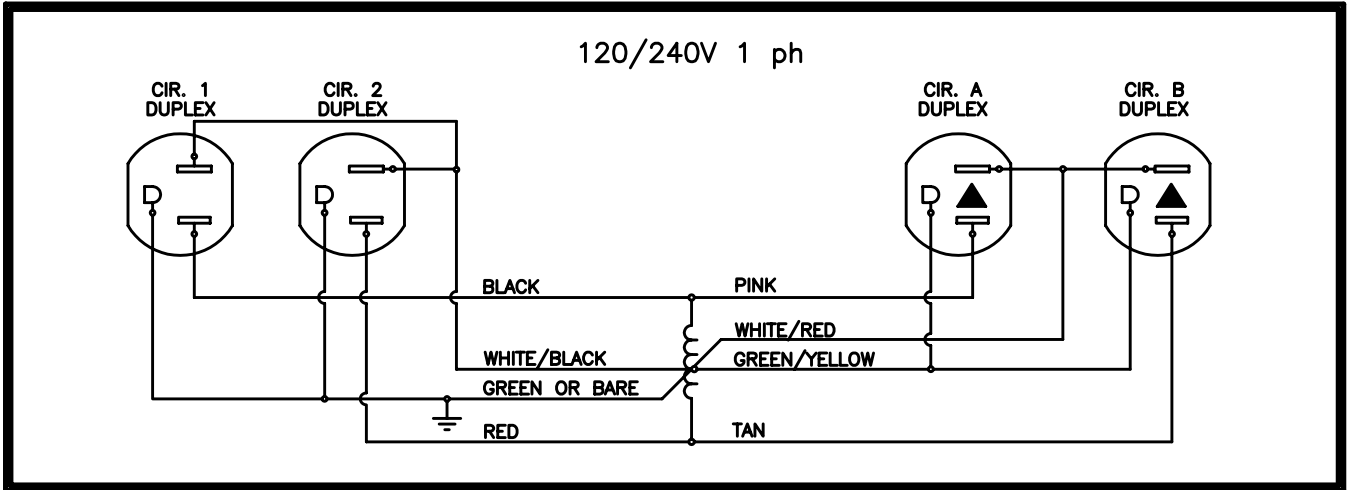

DEFINING “2 + 2” WIRING CONFIGURATIONS

2 + 2 Configuration (8 wire, 4 circuit)

Two Utility Circuits [Evolve’s #1 & #2 circuits] share one neutral wire and one ground wire.
(2 hot [circuit] wires + 1 neutral wire*** + 1 green ground wire* = 4 wires)

Two Dedicated Circuits [Evolve’s “A” & “B” circuits] share one neutral wire and one ground wire.
(2 hot [circuit] wires + 1 neutral wire *** + 1 green/yellow ground wire** = 4 wires)

NOTE:

It is the ground wire that makes the difference between “Utility” and “Dedicated” circuits. Refer to Wiring Schematics found in the Price List.

* A Green ground wire is a “system” ground. This means it could be grounded to any piece of metal, including the Panel.

** A Green/Yellow ground wire is isolated, within the wiring conduit, all the way back to the box at the source (building ground).

*** All Neutral Wires are 10 gauge rather than 12 gauge meaning they are larger than normal, allowing greater protection against “noise” or interference on the circuit.

This page provides an exploded view of a sample configuration highlighting each **Electrical** component required when specifying this configuration.

Components

- A.** EVE8PD42 Power Distribution Housing
Note: 8 wire, 4 circuits (3rd/4th circuits dedicated) labeled A or B.
- B.** EVE8CP16 Jumper Cable
Note: EVE8CP16 connects two powered panels positioned side by side, separated by an Inline Connector
EVE8CP18 connects two powered panels separated by a post.
- C.** EVE8RD Duplex Receptacle
- D.** EVE8CP Pass-Through Cable
Note: Pass-Through Extension Cable (EVE8CPF154) available – extends power capability beyond 208".

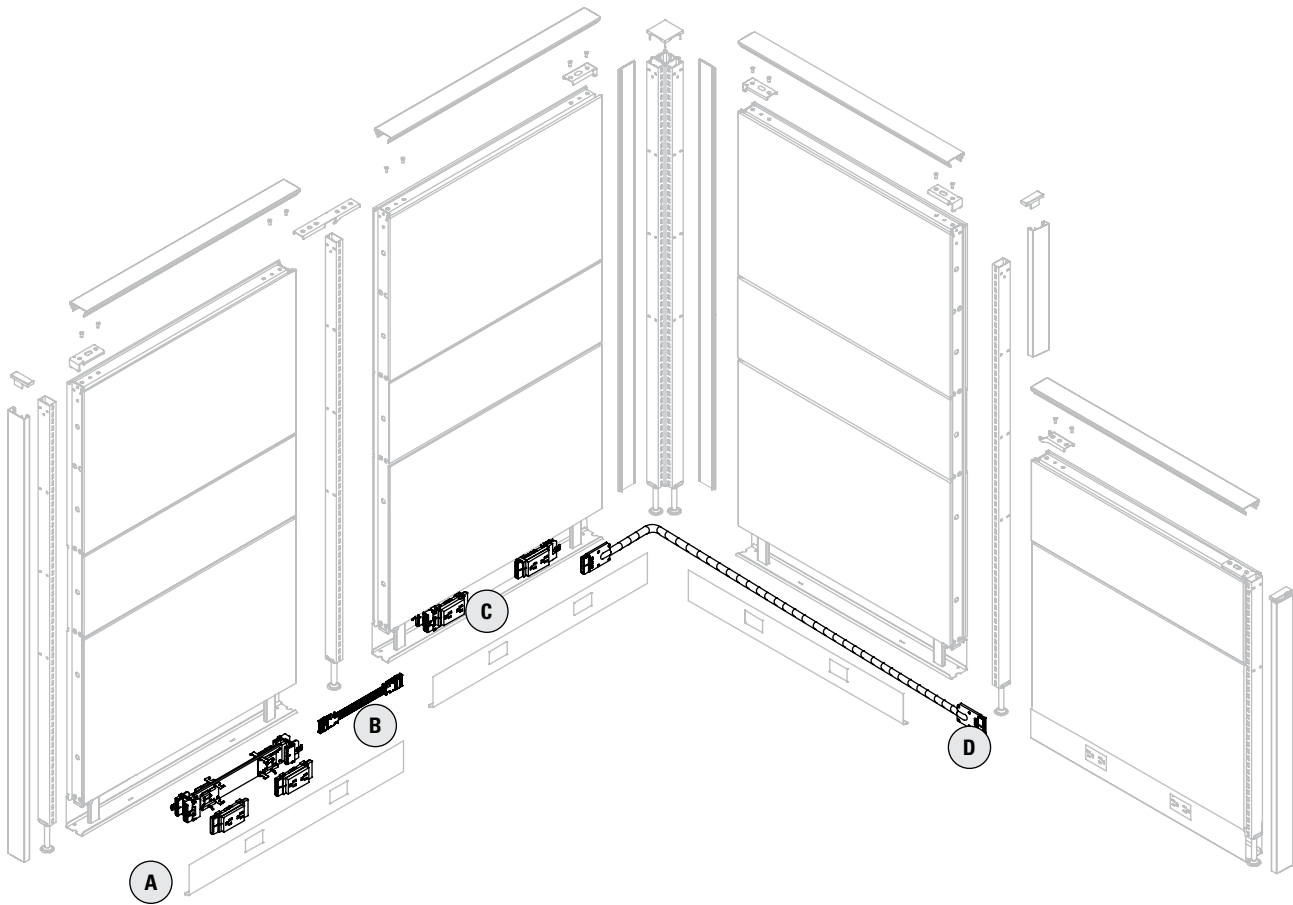

This page provides an exploded view of a sample configuration highlighting each **Beltline Power Panel** component required when specifying this configuration.

- A. EVE8PD36** Power Distribution Housing
 Note: 8 wire, 4 circuits (3rd/4th circuits dedicated) labeled A or B.
- E. EVE8CP18** Jumper Cable
 Note: EVE8CP18 connects two powered panels separated by a post, in a straight line.
- B. EVE8CP17** Jumper Cable
 Note: EVE8CP17 connects two powered panels positioned side by side, separated by an Inline Connector
- F. EVE8CP17** Jumper Cable
 Note: EVE8CP17 connects two powered panels separated by a post, for turns through post.
- C. EVE8RD** Duplex Receptacle
- G. EVE8CPCP** Base to Belt Pass Through Kit
 Note: For use in Chimney Panels only.
- D. EVE8CP** Pass-Through Cable
 Note: Pass-Through Extension Cable (EVE8CPF154) available – extends power capability beyond 208”.

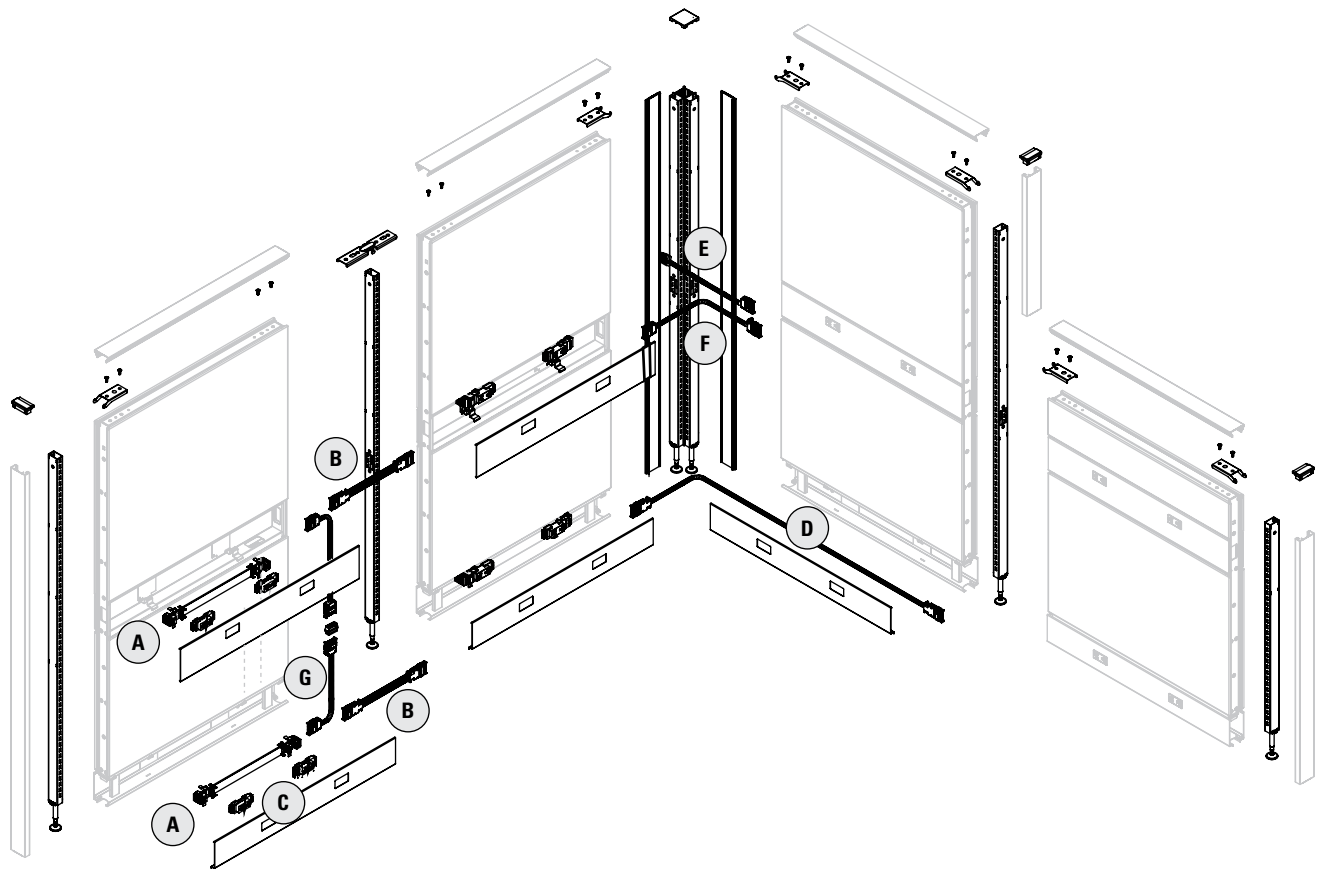

ELECTRICAL

EVE8PD - POWER DISTRIBUTION HOUSING

- Power housing is specified per panel size (e.g. EVE8PD36 is for use in a 36" panel).
- 8 wire, 4 circuits (2+2 configuration).
- Provides two duplex receptacles per panel side on all panel widths except the 24" wide panel.
- 24" wide panel allows for only one (1) duplex receptacle per panel side.
- Each power distribution housing supports 15-20 amps.

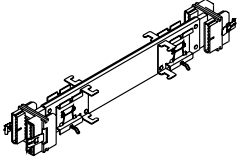
DESCRIPTION	PRODUCT CODE	LIST PRICE	DIMENSIONS/INCHES		
			H	L	D
 Power Distribution Housing	EVE8PD24	163		6 1/4	
	EVE8PD30	220		11 1/2	
	EVE8PD36	231		17 1/2	
	EVE8PD42	237		23 1/2	
	EVE8PD48	257		29 1/2	
	EVE8PD54	258		39 1/4	
	EVE8PD60	259		41 1/2	

EVE8CP16 - JUMPER CABLE

- The EVE8CP16 electrically connects two powered panels positioned side by side, separated by an Inline connector.

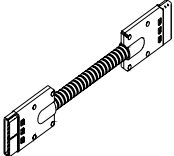
DESCRIPTION	PRODUCT CODE	LIST PRICE	DIMENSIONS/INCHES		
			H	L	D
 Jumper Cable	EVE8CP16	136		16	

EVE8CP - FLEXIBLE MESH JUMPER CABLE

- Used to connect two power distribution housings at the beltline level at 90 degrees.
- 18.5" flexible mesh jumper replaces EVE8CP18 jumper for corner post applications.

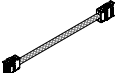
DESCRIPTION	PRODUCT CODE	LIST PRICE	DIMENSIONS/INCHES		
			H	L	D
 Flexible Mesh Jumper Cable	EVE8CP17	126		17 1/2	
	EVE8CP18	156		18 1/2	

EVE8CPCP - CHIMNEY PANEL JUMPER CABLE KIT

- Contains two (2) 17" flexible harnesses and one (1) "I" connector.
- Used to connect electric from the base to the beltline raceway in Beltline Powered Chimney panel.
- Must use in conjunction with base power distribution harness and beltline power distribution harness (sold separately).

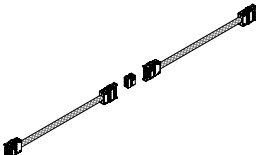
DESCRIPTION	PRODUCT CODE	LIST PRICE	DIMENSIONS/INCHES		
			H	L	D
 Chimney Panel Jumper Cable Kit	EVE8CPCP	341			



ELECTRICAL

EVE8CPXX-H - PASS-THROUGH CABLE

- Flexible metal conduit with wire mesh distributes electrical power through non-powered beams.
- To calculate the length of a Pass-Through Cable, add the widths of the non-powered panels separating the powered panels (panels with distribution housing attached). To this, add 16" (distance from the edge of the panel to the distribution housing x 2).
- Add additional 3" when passing through a post. See the Tips at the beginning of the section for more details.
- Hybrid pass-through cables with wire mesh allows connection at 90 degree post at one end for Evolve panels including Beltline and Power Beam

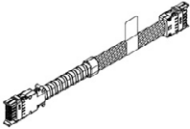
	DESCRIPTION	PRODUCT CODE	LIST PRICE	DIMENSIONS/INCHES		
				H	L	D
	Pass-Through Cable	EVE8CP40-H	211		40	
		EVE8CP46-H	218		46	
		EVE8CP52-H	224		52	
		EVE8CP58-H	238		58	
		EVE8CP64-H	248		64	
		EVE8CP70-H	256		70	
		EVE8CP76-H	258		76	
		EVE8CP82-H	269		82	
		EVE8CP88-H	278		88	
		EVE8CP94-H	285		88	
		EVE8CP100-H	294		100	
		EVE8CP106-H	308		106	
		EVE8CP118-H	323		118	
		EVE8CP130-H	355		130	
		EVE8CP142-H	371		142	
		EVE8CP154-H	388		154	
		EVE8CP172-H	417		172	
		EVE8CP190-H	437		190	
		EVE8CP208-H	454		208	

EVE8CI-1 - "I" CONNECTOR

- Female - Female connector used to connect two Pass-Through Cables

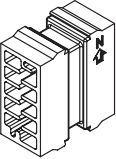
	DESCRIPTION	PRODUCT CODE	LIST PRICE	DIMENSIONS/INCHES		
				H	W	D
	"I" Connector	EVE8CI-1	94			

EVE8RD - DUPLEX RECEPTACLE

- Duplex receptacles are rated for 15 Amps.
- EVE8RD1 = Circuit #1 (utility circuit)
- EVE8RD2 = Circuit #2 (utility circuit)
- EVE8RDA = Circuit A (dedicated)
- EVE8RDB = Circuit B (dedicated)

NOTE:

- EVE8RD1 and EVE8RD2 (#1 and #2 share common ground)
- EVE8RDA and EVE8RDB (A and B share common ground)
- Up to 6 receptacles per circuit (24 per infeed), not to exceed total of 15 Amps per circuit.
- Standard in black. Available in White or Nevada with upcharge, add \$3.00.

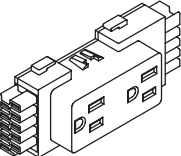
	DESCRIPTION	PRODUCT CODE	LIST PRICE	DIMENSIONS/INCHES		
				H	W	D
	Duplex Receptacle	EVE8RD1	36	2	4 5/8	1 1/4
		EVE8RD2	36	2	4 5/8	1 1/4
		EVE8RDA	36	2	4 5/8	1 1/4
		EVE8RDB	36	2	4 5/8	1 1/4

ELECTRICAL

EVE8RD - DUPLEX RECEPTACLE

- Duplex receptacles are rated for 15 Amps.
- EVE8RD1 = Circuit #1 (utility circuit)
- EVE8RD2 = Circuit #2 (utility circuit)
- EVE8RDA = Circuit A (dedicated)
- EVE8RDB = Circuit B (dedicated)

NOTE:

- EVE8RD1 and EVE8RD2 (#1 and #2 share common ground)
- EVE8RDA and EVE8RDB (A and B share common ground)
- Up to 6 receptacles per circuit (24 per infeed), not to exceed total of 15 Amps per circuit.
- Standard in black. Available in White or Nevada with upcharge, add \$3.00.

DESCRIPTION	PRODUCT CODE	LIST PRICE	DIMENSIONS/INCHES		
			H	W	D
Duplex Receptacle	EVE8RD1	36	2	4 5/8	1 1/4
	EVE8RD2	36	2	4 5/8	1 1/4
	EVE8RDA	36	2	4 5/8	1 1/4
	EVE8RDB	36	2	4 5/8	1 1/4

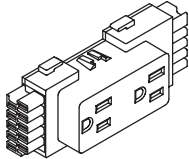

EVE8RDxca - CALIFORNIA CONTROLLED DUPLEX RECEPTACLE

- California Title 24 meets federal and LEED certification guidelines
- Allows circuit to be controlled or switched off when utility is not in use.
- Duplex receptacles are rated for 15 Amps.
- EVE8RD1CA = Circuit #1 (utility circuit)
- EVE8RD2CA = Circuit #2 (utility circuit)
- EVE8RDACA = Circuit A (dedicated)
- EVE8RDBCA = Circuit B (dedicated)

NOTE:

- EVE8RD1CA and EVE8RD2CA (#1 and #2 share common ground)
- EVE8RDACA and EVE8RDBCA (A and B share common ground)
- Up to 6 receptacles per circuit (24 per infeed), not to exceed total of 15 Amps per circuit.
- Available in BLK finish only.

DESCRIPTION	PRODUCT CODE	LIST PRICE	DIMENSIONS/INCHES		
			H	W	D
Duplex Receptacle	EVE8RD1CA	39	2	4 5/8	1 1/4
	EVE8RD2CA	39	2	4 5/8	1 1/4
	EVE8RDACA	39	2	4 5/8	1 1/4
	EVE8RDBCA	39	2	4 5/8	1 1/4

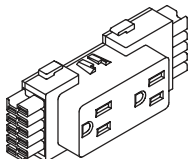

EVE8RD - DUPLEX RECEPTACLE TO CONVERT STANDARD 2 + 2 SYSTEM TO 3 + 1

- Duplex receptacle are rated for 15 Amps
- EVE8RDA-4 = Duplex receptacle A without triangle to be utility circuit
- EVE8RDB-4 = Duplex receptacle B without triangle to be utility circuit

- Up to 6 receptacles per circuit (24 per infeed) not to exude total 15 Amps per circuit
- Standard in black. Available in White or Nevada with upcharge. Add \$3

DESCRIPTION	PRODUCT CODE	LIST PRICE	DIMENSIONS/INCHES		
			H	L	D
Duplex Receptacle	EVE8RDA-4	36	2	4 5/8	1 1/4
	EVE8RDB-4	36	2	4 5/8	1 1/4

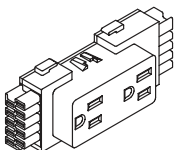

ELECTRICAL

EVEUSB01 - USB MODULE

- Includes two USB ports.
- Available in White and Black.

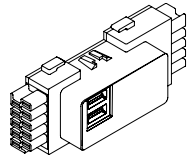

DESCRIPTION	PRODUCT CODE	LIST PRICE	DIMENSIONS/INCHES		
			H	L	D
USB Module - White	EVEUSB01WHT	226	2	4 5/8	1 1/4
USB Module - Black	EVEUSB01BLK	226	2	4 5/8	1 1/4

EVE8FR1 - REVERSIBLE FLOOR POWER ENTRY

- Takes the place of a duplex receptacle by snapping into the base power way or Beltline power way.
- Includes 72" long flexible vinyl conduit.
- Must be hard wired to source power by a licensed electrician.
- Diameter is 0.85"

EVE8FR2 - REVERSIBLE FLOOR POWER ENTRY

- Takes the place of a duplex receptacle by snapping into the base power way or Beltline power way.
- Includes 144" long flexible vinyl conduit.
- Must be hard wired to source power by a licensed electrician.
- Diameter is 0.85"

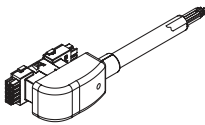

DESCRIPTION	PRODUCT CODE	LIST PRICE	DIMENSIONS/INCHES		
			H	L	D
Reversible Floor Power Entry	EVE8FR1	367		72	
	EVE8FR2	475		144	

EVE8F - FLOOR POWER ENTRY

- Snaps in end of power distribution housing.
- Includes flexible vinyl conduit.
- Must be hard wired to source power by a licensed electrician.
- Diameter is 0.85"

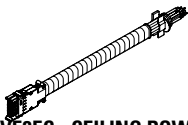

DESCRIPTION	PRODUCT CODE	LIST PRICE	DIMENSIONS/INCHES		
			H	L	D
Floor Power Entry	EVE8F1P	356		72	
	EVE8F2P	460		144	

VE8EC - CEILING POWER ENTRY

- Snaps into the end of a Power Distribution Housing.
- Flexible metal conduit extends into the ceiling through a corner post and post extension.
- Must be hard wired to source power by a licensed electrician.
- 4" junction box included.
- Post extension ordered separately
- Can feed directly into beltline power when Beltline Post Connectors are specified.
- Cannot feed through Inline or End-of-run Connectors.

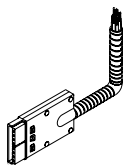

DESCRIPTION	PRODUCT CODE	LIST PRICE	DIMENSIONS/INCHES		
			H	L	D
Ceiling Power Entry	EVE8EC1	284		132	
	EVE8EC2	497		144	
	EVE8EC3	560		180	

ELECTRICAL

EVEENY-2 - HARDWARE POWER ENTRY BOX - NEW YORK

- A licensed electrician must provide hard wire connection within the junction box.
- Not for use in panels less than 36"W.

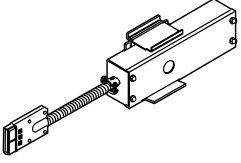
	DESCRIPTION	PRODUCT CODE	LIST PRICE	DIMENSIONS/INCHES		
				H	W	D
	Hardware Power Entry Box - New York	EVEENY2	470	3	28	2 1/5

EVEJBC-1 - HARDWARE JUNCTION BOX - CHICAGO

- Can be retrofitted in any size of panel at the receptacle location.
- Gives access from one side only at each location.
- Customer to supply conduit, wiring, receptacle, and face plate.
- 2 per panel, except 24" panels only one is needed.
- A licensed electrician must provide hardware connection with the junction box.

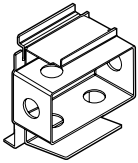
	DESCRIPTION	PRODUCT CODE	LIST PRICE	DIMENSIONS/INCHES		
				H	W	D
	Hardware Junction Box - Chicago	EVEJBC-1	108			

EVDPE - POST EXTENSION DATA/COMM LAY-IN

- Attaches to the top of a post to bring power and/or data cables from the ceiling to the panel power way
- Three-sided power pole with snap-on fourth side.
- Post extension can be opened on one side for lay-in or power and/or data cables.
- Made of aluminum and can be field cut.
- Accommodates up to 25CAT 5 Cables with electric. Accommodates up to 45 CAT 5 Cables without electric.
- Actual size interior dimension of post, 1.80"x 1.80"

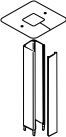
	DESCRIPTION	PRODUCT CODE	LIST PRICE	DIMENSIONS/INCHES		
				H	W	D
	Post Extension Data/Comm Lay-in	EVDPE64	182	64	2	
		EVDPE82	220	82	2	

EVDPE6E - 60° POST EXTENSION DATA/COMM LAY-IN

- Attaches to the top of at 60° corner post to bring power and/or data cables from the ceiling to the panel power way.
- Two-sided power pole with snap-on third side.
- Post extension can be opened on one side for lay-in or power and/or data cables.
- Made of aluminum and can be field cut.
- Accommodates up to 6 CAT 5 Cables with electric. Accommodates up to 20 CAT 5 Cables without electric.

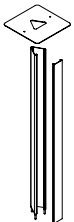
	DESCRIPTION	PRODUCT CODE	LIST PRICE	DIMENSIONS/INCHES		
				H	W	D
	60° Post Extension Data/Comm Lay-in	EVDPE6E64	182	64	2	
		EVDPE6E82	220	82	2	



ELECTRICAL

EVDP4E - 45° POST EXTENSION DATA/COMM LAY-IN

- Attaches to the top of at 45° corner post to bring power and/or data cables from the ceiling to the panel power way.
- Two-sided power pole with snap-on third side.
- Post extension can be opened on one side for lay-in or power and/or data cables.
- Made of aluminum and can be field cut.
- Accommodates up to 6 CAT 5 Cables with electric. Accommodates up to 20 CAT 5 Cables without electric.

	DESCRIPTION	PRODUCT CODE	LIST PRICE	DIMENSIONS/INCHES		
				H	W	D
	45° Post Extension Data/Comm Lay-in	EVDP4E64	190	64	3.65	
		EVDP4E84	166	84	3.65	

EVLEDES - STARTER LED TASK LIGHT

- Undercabinet slim profile LED linear light fixture with lens and On/Off switch.
- May be used as stand-alone or extended with add-on section below (EVLEDES_DSC).
- Plug-in power supply with 72" cord length plus 78" DC cable.
- Includes magnet mounting bracket with optional adhesive metal plate.
- Light enclosure in clear anodizing finish. Color temperature cool white 4000K.
- Lifespan rated 30,000 hours.

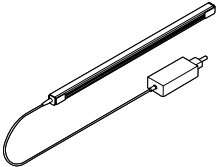
	DESCRIPTION	PRODUCT CODE	LIST PRICE	DIMENSIONS/INCHES		
				H	W	D
	Led Task Light	EVLEDES24	277	1	22.9	1
		EVLEDES36	318	1	33.5	1
		EVLEDES48	354	1	45.5	1

EVLEDES - ADD-ON LED TASK LIGHT

- Undercabinet slim profile LED linear add-on light fixture with lens.
- Daisy chain unit with 39" linking cable, no power supply.
- Add-on units can only be linked up to a total of 48 watts per power supply; this is equivalent to 10 feet of nominal length of light per power supply.
- Includes magnet mounting bracket with optional adhesive metal plate. Light enclosure in clear anodizing finish. Color temperature cool white 4000K. Lifespan rated 30,000 hours.

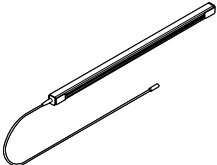
	DESCRIPTION	PRODUCT CODE	LIST PRICE	DIMENSIONS/INCHES		
				H	W	D
	Led Task Light	EVLEDES24DSC	227	1	24	39
		EVLEDES36DSC	267	1	36	39
		EVLEDES48DSC	303	1	48	39

ELECTRICAL

EVLEDESOS - OCCUPANCY SENSOR

- Inline add-on controller for dimming and occupancy sensor.
- Sensor bypass switch.

DESCRIPTION	PRODUCT CODE	LIST PRICE	DIMENSIONS/INCHES		
			H	W	D

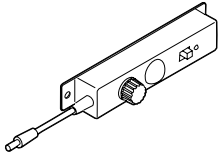

Occupancy Sensor	EVLEDESOS	114	6	2.4	2
------------------	-----------	-----	---	-----	---

EVELEDVS - VOYAGE LED SINGLE LIGHT FIXTURE

- Single arm option with 6 ft. cord.
- Touch & hold dimming capability.
- Brightness adjustment from 100% to 15%.
- Available in Designer White (WHT), Black (BLK) or Silver (SIL).
- Mercury free LEDs and 94% post consumer recyclability by weight.
- Mounting accessories sold separately.

DESCRIPTION	PRODUCT CODE	LIST PRICE	DIMENSIONS/INCHES		
			H	W	D



Voyage LED Single Light Fixture	EVELEDVS	763			
Voyage LED Single Light Fixture w/Occupancy Sensor	EVELEDVSO	1130			

EVELEDVD - VOYAGE LED DOUBLE LIGHT FIXTURE

- Double arm option with 6 ft. cord.
- Touch & hold dimming capability.
- Brightness adjustment from 100% to 15%.
- Available in Designer White (WHT), Black (BLK) or Silver (SIL).
- Mercury free LEDs and 94% post consumer recyclability by weight.
- Mounting accessories sold separately.

DESCRIPTION	PRODUCT CODE	LIST PRICE	DIMENSIONS/INCHES		
			H	W	D



Voyage LED Double Light Fixture	EVELEDVD	775			
Voyage LED Double Light Fixture w/Occupancy Sensor	EVELEDVDO	1146			



ELECTRICAL

EVELEDRS - REVO LED SINGLE LIGHT FIXTURE

- Single arm option with 9 ft. cord.
- Touch & hold dimming capability.
- Brightness adjustment from 100% to 15%.
- Available in Designer White (WHT), Black (BLK) or Silver (SIL).
- Mercury free LEDs and 94% post consumer recyclability by weight.
- Mounting accessories sold separately.

	DESCRIPTION	PRODUCT CODE	LIST PRICE	DIMENSIONS/INCHES		
				H	W	D
	Revo LED Single Light Fixture	EVELEDRS	763			
	Revo LED Single Light Fixture w/Occupancy Sensor	EVELEDRSO	1130			

EVELEDRD - REVO LED DOUBLE LIGHT FIXTURE

- Double arm option with 9 ft. cord.
- Touch & hold dimming capability.
- Brightness adjustment from 100% to 15%.
- Available in Designer White (WHT), Black (BLK) or Silver (SIL).
- Mercury free LEDs and 94% post consumer recyclability by weight.
- Mounting accessories sold separately.

	DESCRIPTION	PRODUCT CODE	LIST PRICE	DIMENSIONS/INCHES		
				H	W	D
	Revo LED Double Light Fixture	EVELEDRD	775			
	Revo LED Double Light Fixture w/Occupancy Sensor	EVELEDRDO	1146			

EVELEDAFS - FREESTANDING BASE

	DESCRIPTION	PRODUCT CODE	LIST PRICE	DIMENSIONS/INCHES		
				H	W	D
	Freestanding Base	EVELEDAFS	216			

EVELEDACM - CLAMP MOUNT

	DESCRIPTION	PRODUCT CODE	LIST PRICE	DIMENSIONS/INCHES		
				H	W	D
	Clamp Mount	EVELEDACM	193			

ELECTRICAL

EVELEDASW - SLATWALL MOUNT

DESCRIPTION	PRODUCT CODE	LIST PRICE	DIMENSIONS/INCHES		
			H	W	D



Slatwall Mount	EVELEDASW	193			
----------------	-----------	-----	--	--	--

EVELEDAPM - PANEL MOUNT

DESCRIPTION	PRODUCT CODE	LIST PRICE	DIMENSIONS/INCHES		
			H	W	D



Panel Mount	EVELEDAPM	193			
-------------	-----------	-----	--	--	--

EVELEDASM - SURFACE MOUNT

DESCRIPTION	PRODUCT CODE	LIST PRICE	DIMENSIONS/INCHES		
			H	W	D



Surface Mount	EVELEDASM	193			
---------------	-----------	-----	--	--	--

EVECC - CORD COVER

- Attaches to panels vertically between modules to provide enclosures for power or data cords.
- Available in 21" and 36" lengths, 6 per pack.
- Can be field cut to required length.

DESCRIPTION	PRODUCT CODE	LIST PRICE	DIMENSIONS/INCHES		
			H	W	D



Inline Cord Cover For use at panel Inline connections	EVECC121	35	21		
	EVECC136	53	36		
Corner Cord Cover For use at panel Inline connections	EVECC221	35	21		
	EVECC236	53	36		



ELECTRICAL

EVH8RC - RACEWAY COVERS

- Raceway Cover with 1.38" x 2.71" duplex receptacle openings.
- Includes up to three receptacle opening shields depending on width of raceway cover.
- Raceway Covers are sold individually.

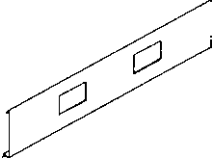
	DESCRIPTION	PRODUCT CODE	LIST PRICE	DIMENSIONS/INCHES		
				H	W	D
	Raceway Covers	EVH8RC18	25	6	18	
		EVH8RC24	36	6	24	
		EVH8RC30	49	6	30	
		EVH8RC36	55	6	36	
		EVH8RC42	61	6	42	
		EVH8RC48	66	6	48	
		EVH8RC54	77	6	54	
		EVH8RC60	85	6	60	

EVEMAE - MINI-ADAPT POWER MODULE

- Attaches to scoop at the back of the worksurface.
- Includes two Simplex outlets.
- 6' black cord
- Available in black only.
- Note: Height (H) is measured above the worksurface.

	DESCRIPTION	PRODUCT CODE	LIST PRICE	DIMENSIONS/INCHES		
				H	W	D
	Mini-Adapt Power Module	EVEMAE1	233	2	3 5/8	3

EVEMAD - MINI-ADAPT POWER MODULE

- Attaches to scoop at the back of the worksurface.
- Includes two Voice/Data Port, Voice/Data Adapter Kit.
- Accepts Cat3, Cat 5, Cat 5e, Cat 6 jacks.
- Available in black only.
- Note: Height (H) is measured above the worksurface.

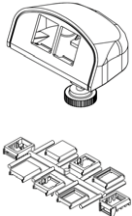
	DESCRIPTION	PRODUCT CODE	LIST PRICE	DIMENSIONS/INCHES		
				H	W	D
	Mini-Adapt Power Module	EVEMAD1	189	2	3 5/8	3

ELECTRICAL

EVED - DUO POWER ADAPTER

- Includes two outlets and two USB ports.
- Clamp mounts above worksurface.
- Available in White only, with Tungsten support bracket.

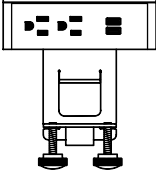
	DESCRIPTION	PRODUCT CODE	LIST PRICE	DIMENSIONS/INCHES		
				H	L	D
	Duo Power Adapter	EVED50	419	1.8	5.5	3.2

EVEDU - DUO UNDER POWER ADAPTER

- Includes two outlets and two USB ports.
- Mounts underneath worksurface or table top with 4 screws.
- Available in White only.

	DESCRIPTION	PRODUCT CODE	LIST PRICE	DIMENSIONS/INCHES		
				H	L	D
	Duo Under Power Adapter	EVEDU51	362	1.8	6.5	2.8

EVETP - TRIO POWER ADAPTER

- Includes three outlets, USB ports and data port.
- Clamp mounts above worksurface.
- Available in White only, with Tungsten support bracket.

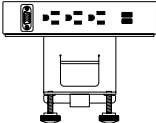
	DESCRIPTION	PRODUCT CODE	LIST PRICE	DIMENSIONS/INCHES		
				H	L	D
	Trio Power Adapter	EVETP53	472	1.8	8	3.2

EVETPU - TRIO UNDER POWER ADAPTER

- Includes three outlets, USB ports and data port.
- Mounts underneath worksurface or table top with 4 screws.
- Available in White only.

	DESCRIPTION	PRODUCT CODE	LIST PRICE	DIMENSIONS/INCHES		
				H	L	D
	Trio Under Power Adapter	EVETPU54	437	1.8	8	3.9

