

worksurfaces

The information listed below provides you with basic features of Compile Worksurfaces.

- Compile thermally fused Worksurfaces are 1" thick and are finished with 3 mm PVC edging on all sides.
- Worksurfaces are predrilled to enable proper alignment with worksurface supports.
- Standard laminate offerings are available in thermally-fused (T). See laminate listings for details.
- Wood grain laminates on corner Worksurfaces up to 42" available in laminate run diagonally for an upcharge. Otherwise, standard horizontal application of laminate will be used.
- Most wood grain laminate Worksurfaces will have matching woodgrain trim unless specified otherwise.
- Depth of the Worksurface scoops are 1 1/8" when measured from the Panel the Worksurface is attached to.
- All Worksurfaces require support items. These are priced separately within this section.
- Grain Direction for Worksurfaces are as follows:

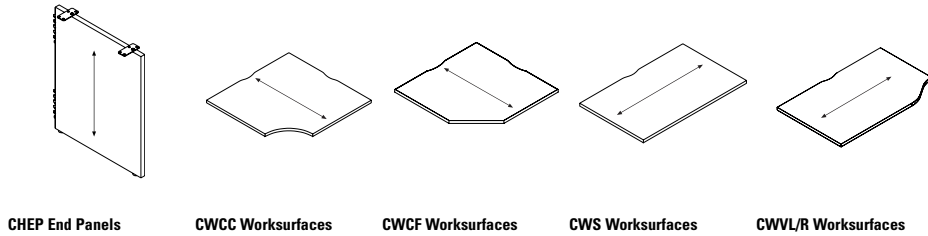

- Communication and electrical wires are routed through a cable scoop located at the back of the Worksurface. When specifying a Straight Worksurface (CWS) or a Curvilinear Worksurface (CWVL), note that the number of cable scoops depends upon the width of the Worksurface. All other Worksurface shapes have one scoop on Panel edges.

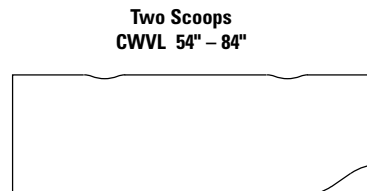
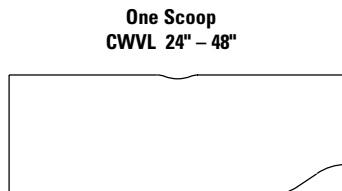
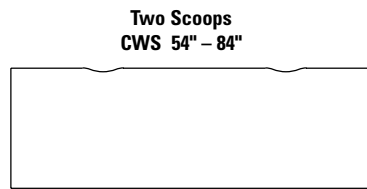
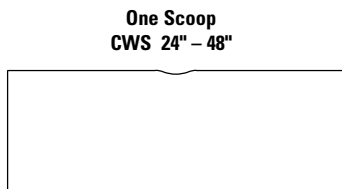

This page provides a three dimensional view of a sample configuration highlighting each **Worksurface** component required when specifying this configuration.

Components

- A.** CWVL2436 Curvilinear Worksurface – Left
 Note: When deepest end equals 24", opposite depth is 18"
 When deepest end equals 30", opposite depth is 24"
- B.** CWCC3618 Corner Curved Worksurface
- C.** CWVR2436 Curvilinear Worksurface – Right

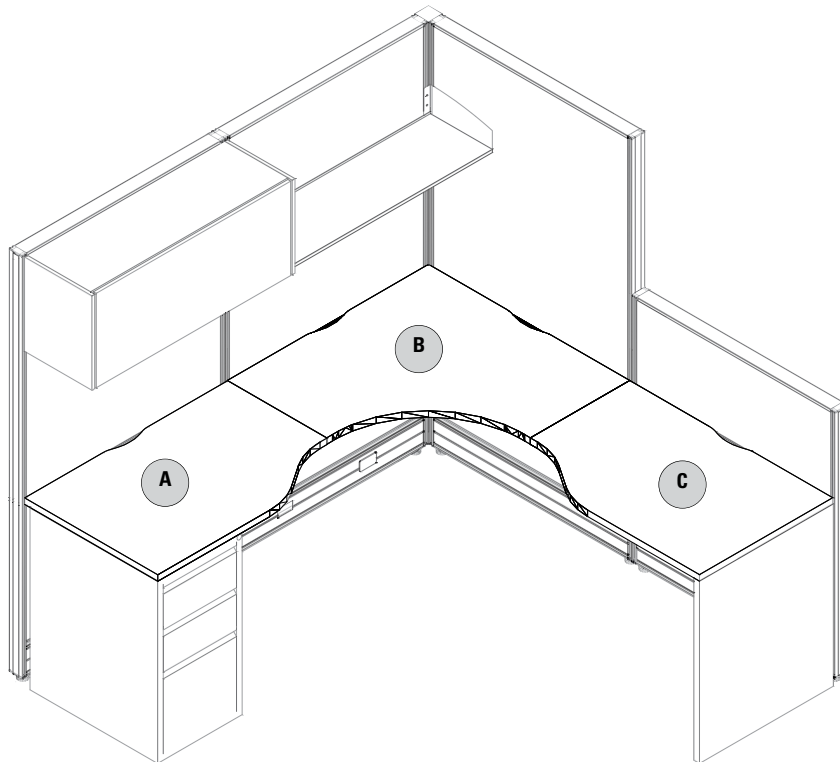

WORKSURFACES

CWS - RECTANGULAR WORKSURFACES

- All tops are thermally fused 1" thick with pilot holes to enable proper alignment with worksurface supports. Wood screws must be used.
- Compile worksurfaces feature a 3mm edge.
- Support hardware must be ordered separately. See the listings in this section.
- Width and depth dimensions listed include a nominal measurement (3/8") to account for wire management between the worksurface and adjoining panel.
- All surfaces over 48" will have two scoops, all others have one.
- Worksurfaces greater than 48" wide require additional structural support.

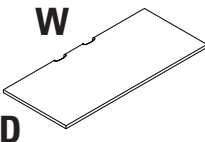
	DESCRIPTION	PRODUCT CODE	LIST PRICE	DIMENSIONS/INCHES		
				D	W	
	Rectangular Worksurfaces - 24" Deep	CWS2424P	139	24	24	
		CWS2430P	149	24	30	
		CWS2436P	167	24	36	
		CWS2442P	214	24	42	
		CWS2448P	258	24	48	
		CWS2454P	301	24	54	
		CWS2460P	339	24	60	
		CWS2466P	354	24	66	
		CWS2472P	367	24	72	
		CWS2478P	590	24	78	
		CWS2484P	597	24	84	
		CWS2490P	626	24	90	
		CWS2496P	668	24	96	
		Rectangular Worksurfaces - 30" Deep	CWS3024P	163	30	24
			CWS3030P	173	30	30
			CWS3036P	205	30	36
CWS3042P	288		30	42		
CWS3048P	301		30	48		
CWS3054P	330		30	54		
CWS3060P	354		30	60		
CWS3066P	366		30	66		
CWS3072P	388		30	72		
CWS3078P	734		30	78		
CWS3084P	748	30	84			



WORKSURFACES

CWSNSC - STRAIGHT WORKSURFACE NO SCOOP

- There is no scoop on this worksurface.
- Worksurface depth is exact, not nominal.
- Support hardware must be ordered separately. See listing in this section of the price book.
- For use with Bridges II or Princeton style legs.
- Surfaces not available in HPW.
- Worksurfaces greater than 48" wide require additional structural support.

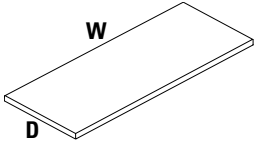
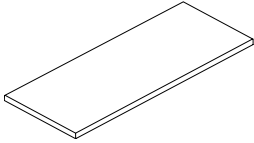
	DESCRIPTION	PRODUCT CODE	LIST PRICE	DIMENSIONS/INCHES	
				D	W
	Straight Worksurface No Scoops - 24" Deep	CWS2424NSC	139	24	24
		CWS2430NSC	149	24	30
		CWS2436NSC	167	24	36
		CWS2442NSC	214	24	42
		CWS2448NSC	258	24	48
		CWS2454NSC	301	24	54
		CWS2460NSC	339	24	60
		CWS2466NSC	354	24	66
		CWS2472NSC	367	24	72
		CWS2478NSC	590	24	78
		CWS2484NSC	597	24	84
		CWS2490NSC	702	24	90
CWS2496NSC	668	24	96		
	Straight Worksurface No Scoops - 30" Deep	CWS3024NSC	163	30	24
		CWS3030NSC	173	30	30
		CWS3036NSC	205	30	36
		CWS3042NSC	288	30	42
		CWS3048NSC	301	30	48
		CWS3054NSC	330	30	54
		CWS3060NSC	354	30	60
		CWS3066NSC	366	30	66
		CWS3072NSC	388	30	72
		CWS3078NSC	734	30	78
		CWS3084NSC	748	30	84

WORKSURFACES

CWSNSCP - RECTANGULAR WORKSURFACE, NO SCOOPS FOR HEIGHT ADJUSTABLE TABLES

- There is no scoop on this work surface.
- Worksurface depth is exact, not nominal.
- Support hardware must be ordered separately. See listing in this section of the price book.
- For use with Height Adjustable Tables
- Surfaces not available in HPW.

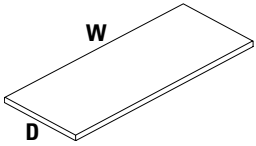
	DESCRIPTION	PRODUCT CODE	LIST PRICE	DIMENSIONS/INCHES		
				H	D	W
	Rectangular Worksurface No Scoops for Height Adjustable Tables	CWS2346NSCP	258	1	23	46
		CWS2352NSCP	301	1	23	52
		CWS2358NSCP	339	1	23	58
		CWS2364NSCP	354	1	23	64
		CWS2370NSCP	367	1	23	70
		CWS2946NSCP	301	1	29	46
		CWS2952NSCP	330	1	29	52
		CWS2958NSCP	354	1	29	58
		CWS2964NSCP	366	1	29	64
		CWS2970NSCP	388	1	29	70

WORKSURFACES

CWSWNSC - WEDGE WORKSURFACE NO SCOOP

- There is no scoop on this worksurface.
- Worksurface depth is exact, not nominal.
- Support hardware must be ordered separately. See listing in this section of the price book.
- For use with Bridges II or Princeton style legs.
- Surfaces not available in HPW.
- Worksurfaces greater than 48" wide require additional structural support.

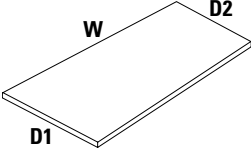
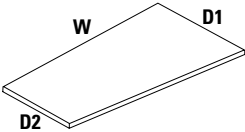
	DESCRIPTION	PRODUCT CODE	LIST PRICE	DIMENSIONS/INCHES		
				D1	D2	W
	Straight Wedge Worksurface No Scoops - Left	CWSW241848NSC	359	24	18	48
		CWSW241854NSC	405	24	18	54
		CWSW241860NSC	446	24	18	36
		CWSW241866NSC	494	24	18	42
		CWSW241872NSC	538	24	18	48
		CWSW302448NSC	446	30	24	60
		CWSW302454NSC	504	30	24	66
		CWSW302460NSC	560	30	24	72
		CWSW302466NSC	615	30	24	78
		CWSW302472NSC	674	30	24	84
	Straight Wedge Worksurface No Scoops - Right	CWSW182448NSC	359	24	18	24
		CWSW182454NSC	405	24	18	30
		CWSW182460NSC	446	24	18	36
		CWSW182466NSC	494	24	18	42
		CWSW182472NSC	538	24	18	48
		CWSW243048NSC	446	30	24	60
		CWSW243054NSC	504	30	24	66
		CWSW243060NSC	560	30	24	72
		CWSW243066NSC	615	30	24	78
		CWSW243072NSC	674	30	24	84

CWSP - RECTANGULAR WORKSURFACES - SPAN A POST

- All tops are thermally fused 1" thick with pilot holes to enable proper alignment with worksurface supports. Wood screws must be used.
- Note: Width and depth dimensions listed include a nominal measurement (3/8") to account for wire management between the worksurface and adjoining panel.
- Compile worksurfaces feature a 3mm edge.
- Support hardware must be ordered separately. See the listings in this section.

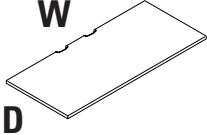
	DESCRIPTION	PRODUCT CODE	LIST PRICE	DIMENSIONS/INCHES		
				D	W	
	Rectangular Worksurfaces - 24" Deep Span a Post	CWSP2426P	167	24	26	
		CWSP2432P	201	24	32	
		CWSP2438P	234	24	38	
		CWSP2444P	264	24	44	
		CWSP2450P	299	24	50	
		CWSP2456P	330	24	56	
		CWSP2462P	437	24	62	
		CWSP2468P	476	24	68	
		CWSP2474P	517	24	74	
		CWSP2480P	556	24	80	
		CWSP2486P	634	24	86	
		Rectangular Worksurfaces - 30" Deep Span a Post	CWSP3026P	209	30	26
			CWSP3032P	250	30	32
			CWSP3038P	296	30	38
CWSP3044P	330		30	44		
CWSP3050P	373		30	50		
CWSP3056P	414		30	56		
CWSP3062P	546		30	62		
CWSP3068P	594		30	68		
CWSP3074P	646		30	74		
CWSP3080P	693		30	80		
CWSP3086P	791	30	86			

WORKSURFACES

CWVR - CURVILINEAR WORKSURFACES - RIGHT

- All tops are thermally fused 1" thick with pilot holes to enable proper alignment with worksurface supports. Wood screws must be used.
- Support hardware must be ordered separately. See the listings in this section.
- Compile worksurfaces feature a 3mm edge.
- Note: Width and depth dimensions listed include a nominal measurement (38") to account for wire management between the worksurface and adjoining panel.
- When deepest end equals 24", the opposite depth is 18". When deepest end equals 30", the opposite depth is 24"
- Worksurfaces greater than 48" wide require additional structural support.

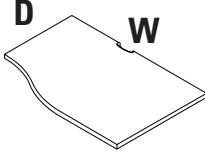
	DESCRIPTION	PRODUCT CODE	LIST PRICE	DIMENSIONS/INCHES		
				D	W	
	Curvilinear Worksurfaces - 24" Deep	CWVR2424P	179	24	24	
		CWVR2430P	185	24	30	
		CWVR2436P	223	24	36	
		CWVR2442P	258	24	42	
		CWVR2448P	295	24	48	
		CWVR2454P	330	24	54	
		CWVR2460P	358	24	60	
		CWVR2466P	396	24	66	
		CWVR2472P	426	24	72	
		CWVR2478P	590	24	78	
		CWVR2484P	597	24	84	
		Curvilinear Worksurfaces - 30" Deep	CWVR3024P	185	30	24
			CWVR3030P	196	30	30
CWVR3036P	231		30	36		
CWVR3042P	317		30	42		
CWVR3048P	330		30	48		
CWVR3054P	366		30	54		
CWVR3060P	396		30	60		
CWVR3066P	426		30	66		
CWVR3072P	453		30	72		
CWVR3078P	734		30	78		
CWVR3084P	748		30	84		

CWVL - CURVILINEAR WORKSURFACES - LEFT

- All tops are thermally fused 1" thick with pilot holes to enable proper alignment with worksurface supports. Wood screws must be used.
- Support hardware must be ordered separately. See the listings in this section.
- Compile worksurfaces feature a 3mm edge.
- Note: Width and depth dimensions listed include a nominal measurement (38") to account for wire management between the worksurface and adjoining panel.
- When deepest end equals 24", the opposite depth is 18". When deepest end equals 30", the opposite depth is 24"

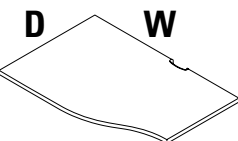
	DESCRIPTION	PRODUCT CODE	LIST PRICE	DIMENSIONS/INCHES		
				D	W	
	Curvilinear Worksurfaces - 24" Deep	CWVL2424P	179	24	24	
		CWVL2430P	185	24	30	
		CWVL2436P	223	24	36	
		CWVL2442P	258	24	42	
		CWVL2448P	295	24	48	
		CWVL2454P	330	24	54	
		CWVL2460P	358	24	60	
		CWVL2466P	396	24	66	
		CWVL2472P	426	24	72	
		CWVL2478P	590	24	78	
		CWVL2484P	597	24	84	
		Curvilinear Worksurfaces - 30" Deep	CWVL3024P	185	30	24
			CWVL3030P	196	30	30
CWVL3036P	231		30	36		
CWVL3042P	317		30	42		
CWVL3048P	330		30	48		
CWVL3054P	366		30	54		
CWVL3060P	396		30	60		
CWVL3066P	426		30	66		
CWVL3072P	453		30	72		
CWVL3078P	734		30	78		
CWVL3084P	748		30	84		



WORKSURFACES

CWCC - CORNER CURVED WORKSURFACES

- All tops are thermally fused 1" thick with pilot holes to enable proper alignment with worksurface supports. Wood screws must be used.
- Compile worksurfaces feature a 3mm edge.
- Support hardware must be ordered separately. See the listings in this section.
- Note: Width and depth dimensions listed include a nominal measurement (3/8") to account for wire management between the worksurface and adjoining panel.
- Note: Wood grain laminates do not run diagonally on corner worksurfaces.
- Worksurfaces greater than 48" wide require additional structural support.

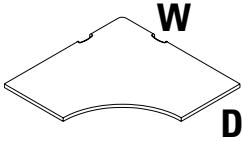
	DESCRIPTION	PRODUCT CODE	LIST PRICE	DIMENSIONS/INCHES	
				D	W
	Corner Curved Worksurfaces - 36"	CWCC3618P	466	18	36
		CWCC3624P	511	24	36
	Corner Curved Worksurfaces - 42"	CWCC4224P	689	24	42
		CWCC4230P	750	30	42
	Corner Curved Worksurfaces - 48"	CWCC4824P	806	24	48
		CWCC4830P	844	30	48

CWCF - FIVE SIDED WORKSURFACES

- All tops are thermally fused 1" thick with pilot holes to enable proper alignment with worksurface supports. Wood screws must be used.
- Compile worksurfaces feature a 3mm edge.
- Support hardware must be ordered separately. See the listings in this section.
- Note: Width and depth dimensions listed include a nominal measurement (3/8") to account for wire management between the worksurface and adjoining panel.
- Note: Wood grain laminates do not run diagonally on corner worksurfaces.

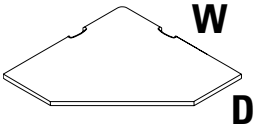
	DESCRIPTION	PRODUCT CODE	LIST PRICE	DIMENSIONS/INCHES	
				D	W
	Five Sided Worksurface - 36"	CWCF3618P	461	18	36
		CWCF3624P	511	24	36
	Five Sided Worksurface - 42"	CWCF4224P	689	24	42
		CWCF4230P	750	30	42
	Five Sided Worksurface - 48"	CWCF4824P	806	24	48
		CWCF4830P	844	30	48

WORKSURFACES

CWC6 - CURVED CORNER WORKSURFACE FOR 60° POST

- All tops are thermally fused 1" thick with pilot holes to enable proper alignment with worksurface supports. Wood screws must be used.
- Compile worksurfaces feature a 3mm edge.
- Support hardware must be ordered separately. See the listings in this section.
- Note: Width and depth dimensions listed include a nominal measurement (3/8") to account for wire management between the worksurface and adjoining panel.
- Note: Wood grain laminates do not run diagonally on corner worksurfaces.
- Worksurfaces greater than 48" wide require additional structural support.

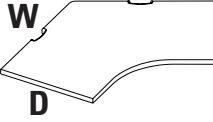
	DESCRIPTION	PRODUCT CODE	LIST PRICE TF	DIMENSIONS/INCHES	
				D	W
	Curved Corner Worksurface for 60° Post - 24"	CWC62424P	435	24	24
		CWC62430P	773	24	30
		CWC62436P	868	24	36
		CWC62442P	1327	24	42
		CWC62448P	1447	24	48
	Curved Corner Worksurface for 60° Post - 30"	CWC63024P	435	30	24
		CWC63030P	773	30	30
		CWC63036P	868	30	36
		CWC63042P	1327	30	42
		CWC63048P	1447	30	48

CWC6L - EXTENDED CURVED CORNER - LEFT

- There are three cable scoops on this worksurface
- Support hardware must be ordered separately. See listing in this section of the price list
- Note: Wood Grain Laminates do not run diagonally on Extended Curved Corners

	DESCRIPTION	PRODUCT CODE	LIST PRICE	DIMENSIONS/INCHES		
				D1	D2	W
	Extended Curved Corner - 36" x 24"	CWC6L362448P	630	36	24	48
		CWC6L362460P	687	36	24	60
		CWC6L362466P	754	36	24	66
		CWC6L362472P	834	36	24	72
		CWC6L362478P	891	36	24	78
	CWC6L362484P	959	36	24	84	
	Extended Curved Corner - 42" x 24"	CWC6L422460P	723	42	24	60
		CWC6L422466P	792	42	24	66
		CWC6L422472P	879	42	24	72
		CWC6L422478P	938	42	24	78
		CWC6L422484P	1012	42	24	84
	Extended Curved Corner - 42" x 30"	CWC6L423060P	813	42	30	60
		CWC6L423066P	891	42	30	66
		CWC6L423072P	975	42	30	72
		CWC6L423078P	1044	42	30	78
		CWC6L423084P	1113	42	30	84
	Extended Curved Corner - 48" x 24"	CWC6L482460P	855	48	24	60
		CWC6L482466P	924	48	24	66
		CWC6L482472P	992	48	24	72
		CWC6L482478P	1092	48	24	78
		CWC6L482484P	1135	48	24	84
	Extended Curved Corner - 48" x 30"	CWC6L483060P	905	48	30	60
		CWC6L483066P	985	48	30	66
		CWC6L483072P	1069	48	30	72
		CWC6L483078P	1150	48	30	78
		CWC6L483084P	1201	48	30	84



WORKSURFACES

CWCER - EXTENDED CURVED CORNER - RIGHT

- There are three cable scoops on this worksurface
- Support hardware must be ordered separately. See listing in this section of the price list
- Note: Wood Grain Laminates do not run diagonally on Extended Curved Corners
- Worksurfaces greater than 48" wide require additional structural support.

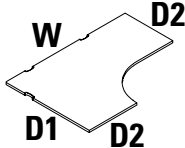
	DESCRIPTION	PRODUCT CODE	LIST PRICE	DIMENSIONS/INCHES		
				D1	D2	W
	Extended Curved Corner - 36" x 24"	CWCER362448P	630	36	24	48
		CWCER362460P	687	36	24	60
		CWCER362466P	754	36	24	66
		CWCER362472P	834	36	24	72
		CWCER362478P	891	36	24	78
		CWCER362484P	959	36	24	84
	Extended Curved Corner - 42" x 24"	CWCER422460P	723	42	24	60
		CWCER422466P	792	42	24	66
		CWCER422472P	879	42	24	72
		CWCER422478P	938	42	24	78
		CWCER422484P	1012	42	24	84
	Extended Curved Corner - 42" x 30"	CWCER423060P	813	42	30	60
		CWCER423066P	891	42	30	66
		CWCER423072P	975	42	30	72
		CWCER423078P	1044	42	30	78
		CWCER423084P	1113	42	30	84
	Extended Curved Corner - 48" x 24"	CWCER482460P	855	48	24	60
		CWCER482466P	924	48	24	66
		CWCER482472P	992	48	24	72
		CWCER482478P	1092	48	24	78
		CWCER482484P	1135	48	24	84
	Extended Curved Corner - 48" x 30"	CWCER483060P	905	48	30	60
		CWCER483066P	985	48	30	66
		CWCER483072P	1069	48	30	72
		CWCER483078P	1150	48	30	78
		CWCER483084P	1201	48	30	84

CWD - "D" WORKSURFACE

- Support hardware must be ordered separately. See listing in this section of the price list
- Monoleg is included

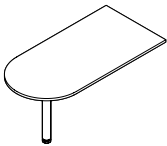
	DESCRIPTION	PRODUCT CODE	LIST PRICE	DIMENSIONS/INCHES	
				D	W
	"D" Worksurface - 24"	CWD2442P	516	24	42
		CWD2448P	530	24	48
		CWD2460P	556	24	60
		CWD2472P	594	24	72
	"D" Worksurface - 30"	CWD3042P	559	30	42
		CWD3048P	566	30	48
		CWD3060P	594	30	60
		CWD3072P	659	30	72

WORKSURFACES

CWH - HATCHET WORKSURFACE (LEFT SHOWN)

- Cable scoop is in the center of the 36" wide edge.
- Support hardware must be ordered separately. See listing in this section of the price list
- Monoleg is included
- Must be specified either left or right handed.
- Note: Wood Grain Laminates do not run diagonally on Hatchet Corners
- Worksurfaces greater than 48" wide require additional structural support.

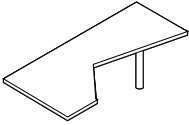
	DESCRIPTION	PRODUCT CODE	LIST PRICE	DIMENSIONS/INCHES		
				D1	D2	W
	Hatchet Worksurface - Left	CWHL3672P	1133	36	30	72
	Hatchet Worksurface - Right	CWHR3672P	1133	36	30	72

Right Shown

CWSW - STRAIGHT WEDGE WORKSURFACES

- Support hardware must be ordered separately. See the listings in this section.
- Must be specified either left or right handed.

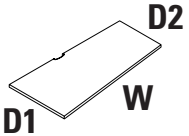
	DESCRIPTION	PRODUCT CODE	LIST PRICE	DIMENSIONS/INCHES		
				D1	D2	W
	Straight Wedge Worksurface - Left	CWSW241848P	359	24	18	48
		CWSW241854P	405	24	18	54
		CWSW241860P	446	24	18	60
		CWSW241866P	494	24	18	66
		CWSW241872P	538	24	18	72
		CWSW302448P	446	30	24	48
	CWSW302454P	504	30	24	54	
	CWSW302460P	560	30	24	60	
	CWSW302466P	615	30	24	66	
	CWSW302472P	674	30	24	72	
	Straight Wedge Worksurface - Right	CWSW182448P	359	18	24	48
		CWSW182454P	405	18	24	54
		CWSW182460P	446	18	24	60
		CWSW182466P	494	18	24	66
CWSW182472P		538	18	24	72	
CWSW243048P		446	24	30	48	
CWSW243054P		504	24	30	54	
CWSW243060P		560	24	30	60	
CWSW243066P	615	24	30	66		
CWSW243072P	674	24	30	72		

CWQR - QUARTER ROUND PANEL WORKSURFACE

- The worksurface edge running along the panel is a slightly different length than that of the worksurface end, causing the surface to be handed.
- Left hand surface shown.
- Support hardware must be ordered separately. See the listings in this section.

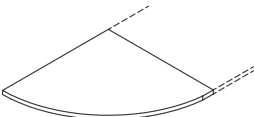
	DESCRIPTION	PRODUCT CODE	LIST PRICE	DIMENSIONS/INCHES	
				D	W
	Quarter Round Panel Worksurface - Left	CWQRL2424	214	24	24
		CWQRL3030	283	30	30
	Quarter Round Panel Worksurface - Right	CWQRR2424	214	24	24
		CWQRR3030	283	30	30



WORKSURFACES

CWQRC - QUARTER ROUND PANEL CORNER WORKSURFACE

- Wraps around a 90° corner post.
- Support hardware must be ordered separately. See the listing in this section.
- Worksurfaces greater than 48" wide require additional structural support.

DESCRIPTION	PRODUCT CODE	LIST PRICE	DIMENSIONS/INCHES	
			D	W
Quarter Round Panel Corner Worksurface	CWQRC2424	257	24	24
	CWQRC3030	316	30	30



CWT - STRAIGHT TRANSACTION WORKSURFACE

- Support hardware must be ordered separately. See the listings in this section.
- Compile worksurfaces feature a 3mm edge.

DESCRIPTION	PRODUCT CODE	LIST PRICE	DIMENSIONS/INCHES	
			D	W
Straight Transaction Worksurface	CWT1512	64	15	12
	CWT1518	85	15	18
	CWT1524	101	15	24
	CWT1530	121	15	30
	CWT1536	138	15	36
	CWT1542	154	15	42
	CWT1548	175	15	48
	CWT1554	191	15	54
	CWT1560	212	15	60
	CWT1566	227	15	66
	CWT1572	247	15	72
	CWT1578	264	15	78
	CWT1584	282	15	84

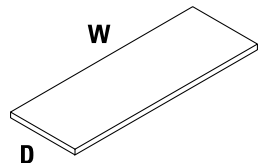

CWTE - END TRANSACTION SURFACE

- Support hardware must be ordered separately. See the listings in this section.
- Extends 1.5" past end of run.
- Compile worksurfaces feature a 3mm edge.

DESCRIPTION	PRODUCT CODE	LIST PRICE	DIMENSIONS/INCHES	
			D	W
End Transaction Surface	CWTE1512	85	15	14
	CWTE1518	101	15	20
	CWTE1524	121	15	26
	CWTE1530	138	15	32
	CWTE1536	154	15	38
	CWTE1542	175	15	44
	CWTE1548	191	15	50
	CWTE1554	212	15	56
	CWTE1560	227	15	62
	CWTE1566	247	15	68
	CWTE1572	264	15	74

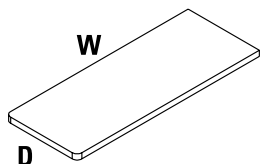

WORKSURFACES

CWTCL - "L" CORNER TRANSACTION SURFACE

- Support hardware must be ordered separately. See the listings in this section.
- When specifying this item along with a straight surface, deduct 12" from each return side.
- Worksurfaces greater than 48" wide require additional structural support.

DESCRIPTION	PRODUCT CODE	LIST PRICE	DIMENSIONS/INCHES	
			D	W
"L" Corner Transaction Surface	CWTCL90	180	15	21

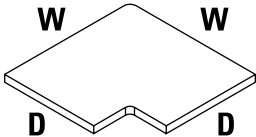

CW9T - CORNER TRANSACTION SURFACE FOR 90° POST

- Support hardware must be ordered separately. See the listing in this section.

DESCRIPTION	PRODUCT CODE	LIST PRICE	DIMENSIONS/INCHES	
			D	W
Corner Transaction Surface for 90° Post	CW9T1524	245	15	32.861
	CW9T1530	292	15	38.861
	CW9T1536	338	15	44.861
	CW9T1542	383	15	50.861
	CW9T1548	434	15	56.861

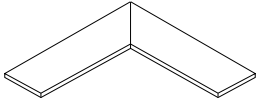

CHCB2 - CORNER BRACKET

- Attaches the corner of any worksurface to a panel connector.
- Priced and shipped in pairs.
- Available in standard paint colors.
- Cannot be used off modular.
- Can be used when a panel is the same depth as the worksurface in the front and back application.

DESCRIPTION	PRODUCT CODE	LIST PRICE	DIMENSIONS/INCHES	
			D	W
Corner Bracket	CHCB2	22	2.5	

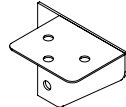

CHWB1 - MID SPAN SUPPORT BRACKET

- Does not need to be on module.
- Used when a panel exceeds the depth of the adjacent worksurface.
- Can only be used with a Segmented Panel.
- Comes in unfinished zinc.

DESCRIPTION	PRODUCT CODE	LIST PRICE	DIMENSIONS/INCHES	
			D	W
Mid Span Support Bracket	CHWB1	14		

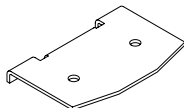

WORKSURFACES

CHC15 & CHC22- CANTILEVER

- Attaches a worksurface to a panel.
- Use one cantilever to support two convergent worksurfaces when specified with 3 Flat Brackets or two cantilevers with one flat bracket to support two convergent worksurfaces.
- Does not include Flat Brackets.
- Priced individually
- Specify handedness of each cantilever
- Available in standard paint colors.
- Right and left Cantilever needs to be specified unless flat brackets are also specified.

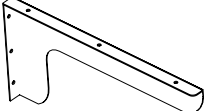
	DESCRIPTION	PRODUCT CODE	LIST PRICE	DIMENSIONS/INCHES	
				D	W
	Cantilever - 15"	CHC15L	50	15	6
		CHC15R	50	15	6
	Cantilever - 22"	CHC22L	77	22	6
		CHC22R	77	22	6

CMHC - WORKSURFACE SUPPORT CHANNEL

- Support channel attaches to underside of worksurface with screws
- Support channel should be 14" shorter than top length.
- Screws are included.
- Only available in Black.
- Tops with post legs should be specified with support channel for structural reinforcement.

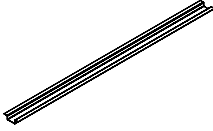
	DESCRIPTION	PRODUCT CODE	LIST PRICE	DIMENSIONS/INCHES	
				L	D
	Worksurface Support Channel	CMHC40 - for 54" wide table	84	40	5
		CMHC46 - for 60" wide table	91	46	5
		CMHC52 - for 66" wide table	101	52	5
		CMHC58 - for 72" wide table	114	58	5
		CMHC64 - for 78" wide table	124	64	5
		CMHC70 - for 84" wide table	138	70	5

CHFB1 - FLAT BRACKET

- Use in conjunction with Cantilever to make it a shared Cantilever to support convergent worksurfaces.
- Used at the front of 2 convergent worksurfaces to keep worksurfaces flush at seams.
- Available in Black only.

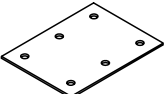
	DESCRIPTION	PRODUCT CODE	LIST PRICE	DIMENSIONS/INCHES	
				D	W
	Flat Bracket	CHFB1	21	3	4

CHTB2 - TRANSACTION TOP BRACKETS

- Securely attaches a transaction surface to the top of a panel.
- One pair must be on each side of transaction surface.
- Priced and shipped in pairs.
- Available in Anodized Aluminum only.

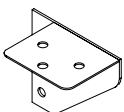
	DESCRIPTION	PRODUCT CODE	LIST PRICE	DIMENSIONS/INCHES	
				D	W
	Flat Bracket	CHTB2	22	2.5	

WORKSURFACES

CHEP - END PANEL

- Supports the worksurface and enhances the stability of connected panels.
- Provides solid support at the end of a run of worksurfaces.
- Finished in thermally-fused laminate.
- Includes flat brackets and hardware.
- End panel height is inclusive of panel glides extended to their fullest height.
- If wood grains is selected, grain runs vertically.

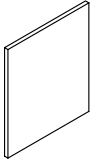
	DESCRIPTION	PRODUCT CODE	LIST PRICE	DIMENSIONS/INCHES	
				D	W
	End Panel - 28"High	CHEP2924	264	28	24
		CHEP2930	311	28	30

CHMSL - MID SUPPORT LEG

- Provides support for a worksurface.
- Includes leveling glide, PVC Sleeve and 4.8" x 4.8" attachment plate.
- 1.5" diameter.
- Available in standard paint colors.

	DESCRIPTION	PRODUCT CODE	LIST PRICE	DIMENSIONS/INCHES
				H
	Mid Support Leg - Round	CHMSL1	91	28
	Mid Support Leg - Square	CHMSL2	91	28

CMHCL & CHHCL - CORNER LEG WITH LEVELER

- Provides support for a worksurface.
- Includes leveling glide, PVC Sleeve and attachment plate.
- 1.5" diameter
- Available in standard paint colors.
- Legs can be used in the corner of a single worksurface or be rotated 45 degrees to support the corners of two worksurfaces.

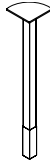
	DESCRIPTION	PRODUCT CODE	LIST PRICE	DIMENSIONS/INCHES
				H
 	Corner Leg Round	CMHCL1	127	28
	Corner Leg Square	CMHCL2	127	28

CHWS - 5" SURFACE TO STORAGE SUPPORT LEG

- Provides support for a worksurface.
- Includes leveling glide, PVC Sleeve and 4.8" x 4.8" attachment plate.
- 1.5" diameter.
- Available in standard paint colors.

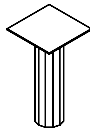
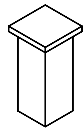
	DESCRIPTION	PRODUCT CODE	LIST PRICE	DIMENSIONS/INCHES
				H
 	5" Surface to Storage Support Leg - Round	CHWSRL01	59	4.5
	5" Surface to Storage Support Leg - Square	CHWSSL01	59	4.5

Round Square



WORKSURFACES

CHMEGR - METAL END GABLE - RIGHT

- Supports the worksurface and enhances the stability of connected panels.
- Includes a levelling glide and decorative PVC sleeve to cover the glide.
- Available in standard paint colors.

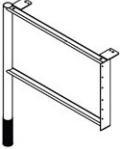
DESCRIPTION	PRODUCT CODE	LIST PRICE	DIMENSIONS/INCHES		
			H	D	W
 Metal End Gable - Right	CHMEG18R	267	28	17	4
	CHMEG24R	285	28	23	4
	CHMEG30R	300	28	29	4

CHMEGL - METAL END GABLE - LEFT

- Supports the worksurface and enhances the stability of connected panels.
- Includes a levelling glide and decorative PVC sleeve to cover the glide.
- Available in standard paint colors.

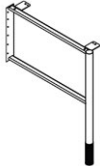
DESCRIPTION	PRODUCT CODE	LIST PRICE	DIMENSIONS/INCHES		
			H	W	D
 Metal End Gable - Left	CHMEG18L	267	28	17	4
	CHMEG24L	285	28	23	4
	CHMEG30L	300	28	29	4

CHMSL - METAL SUPPORT LEG

- Supports two adjoining worksurfaces and enhances the stability of connected panels.
- Includes a levelling glide and decorative PVC sleeve to cover the glide.
- Available in standard paint colors.
- Flat brackets recommended to ensure alignment of neighboring surface.

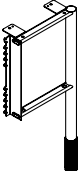
DESCRIPTION	PRODUCT CODE	LIST PRICE	DIMENSIONS/INCHES		
			H	W	D
 Metal Support Leg	CHMSL12	239	28	11	4

PEDESTAL FILLER BRACKET

- Screws to back of pedestal
- Fills the gap between the pedestal and panel when wing pnael is not used.

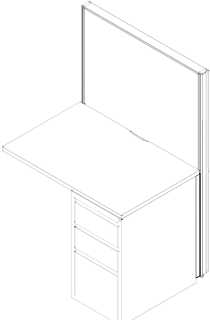
DESCRIPTION	PRODUCT CODE	LIST PRICE	DIMENSIONS/INCHES	
			D	W
 Pedestal Filler Bracket-	CHPBF	60	26.875	1.375

WORKSURFACES

CHPEDB - FLUSH PEDESTAL BRACKET

- Attaches metal or laminate storage or desking, to Compile panels for additional panel support
- Used in flush mount applications only
- Use CHPBF Pedestal Filler Bracket with CS19xx Pedestals and standard depth worksurfaces

DESCRIPTION	PRODUCT CODE	LIST PRICE	DIMENSIONS/INCHES		
			H	W	D
Flush Pedestal Bracket	CHPEDB	29	8	1	1

