

The information listed below provides you with basic features of Compile Worksurfaces.

- Compile thermally fused Worksurfaces are 1" thick and are finished with 3 mm PVC edging on all sides.
- Worksurfaces are predrilled to enable proper alignment with worksurface supports.
- Standard laminate offerings are available in thermally-fused (T). See laminate listings for details.
- Laminate Worksurfaces will have matching woodgrain trim only.
- Depth of the Worksurface scoops are 1 1/8" when measured from the Panel the Worksurface is attached to.
- All Worksurfaces require support items. These are priced separately within this section.
- Grain Direction for Worksurfaces are as follows:

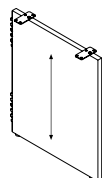

CHEP End Panels

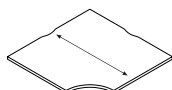

CWCC Worksurfaces

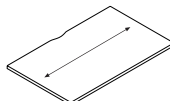

CWS Worksurfaces

- Communication and electrical wires are routed through a cable scoop located at the back of the Worksurface. When specifying a Straight Worksurface (CWS) or a Curvilinear Worksurface (CWVL), note that the number of cable scoops depends upon the width of the Worksurface. All other Worksurface shapes have one scoop on Panel edges.

**One Scoop
CWS 24" – 48"**

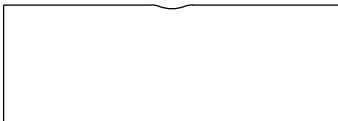

**Two Scoops
CWS 54" – 84"**



This page provides a three dimensional view of a sample configuration highlighting each **Worksurface** component required when specifying this configuration.

Components

- A. QSCWS2424P Rectangular Worksurface
- B. QSCWCC3624P Corner Curved Worksurface
- C. QSCWS2424P Rectangular Worksurface

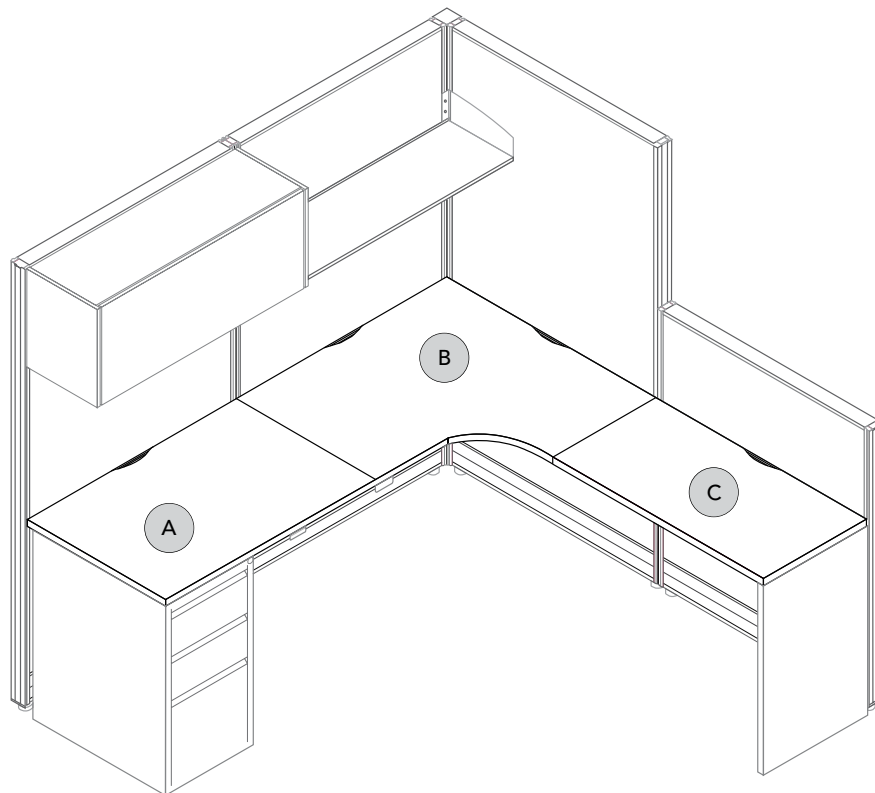

WORKSURFACES

CWS - RECTANGULAR WORKSURFACES

- All tops are thermally fused 1" thick with pilot holes to enable proper alignment with worksurface supports. Wood screws must be used.
- Compile worksurfaces feature a 3mm edge.
- Support hardware must be ordered separately. See the listings in this section.
- Width and depth dimensions listed include a nominal measurement (3/8") to account for wire management between the worksurface and adjoining panel.
- All surfaces over 48" will have two scoops, all others have one.
- Worksurfaces greater than 48" wide require additional structural support.

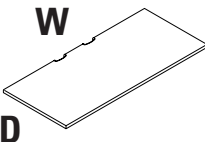
	DESCRIPTION	PRODUCT CODE	LIST PRICE	DIMENSIONS/INCHES	
				D	W
	Rectangular Worksurfaces - 24" Deep	QSCWS2424P	139	24	24
		QSCWS2430P	149	24	30
		QSCWS2436P	167	24	36
		QSCWS2442P	214	24	42
		QSCWS2448P	258	24	48
		QSCWS2454P	301	24	54
		QSCWS2460P	339	24	60
		QSCWS2466P	354	24	66
		QSCWS2472P	367	24	72
			Rectangular Worksurfaces - 30" Deep	QSCWS3024P	163
QSCWS3030P	173			30	30
QSCWS3036P	205			30	36
QSCWS3042P	288			30	42
QSCWS3048P	301			30	48
QSCWS3054P	330			30	54
QSCWS3060P	354			30	60
QSCWS3066P	366			30	66
QSCWS3072P	388			30	72



WORKSURFACES

CWCC - CORNER CURVED WORKSURFACES

- All tops are thermally fused 1" thick with pilot holes to enable proper alignment with worksurface supports. Wood screws must be used.
- Compile worksurfaces feature a 3mm edge.
- Support hardware must be ordered separately. See the listings in this section.
- Note: Width and depth dimensions listed include a nominal measurement (38") to account for wire management between the worksurface and adjoining panel.
- Note: Wood grain laminates do not run diagonally on corner worksurfaces.
- Worksurfaces greater than 48" wide require additional structural support.

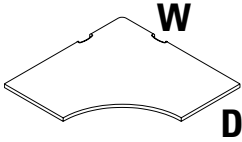
	DESCRIPTION	PRODUCT CODE	LIST PRICE	DIMENSIONS/INCHES	
				D	W
	Corner Curved Worksurfaces - 36"	QSCWCC3624P	511	24	36
	Corner Curved Worksurfaces - 42"	QSCWCC4224P QSCWCC4230P	689 750	24 30	42 42

WORKSURFACES

CWSNSCP - RECTANGULAR WORKSURFACE, NO SCOOPS FOR HEIGHT ADJUSTABLE BASES

- There is no scoop on this work surface.
- Worksurface depth is exact, not nominal.
- Support hardware must be ordered separately. See listing in this section of the price book.
- For use with Height Adjustable Bases
- Surfaces not available in HPW.

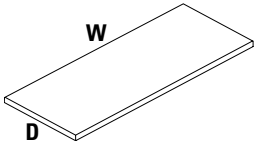
	DESCRIPTION	PRODUCT CODE	LIST PRICE	DIMENSIONS/INCHES		
				H	D	W
	Rectangular Worksurface No Scoops for Height Adjustable Bases	QSCWS2346NSCP	258	1	23	46
		QSCWS2352NSCP	301	1	23	52
		QSCWS2358NSCP	339	1	23	58
		QSCWS2364NSCP	354	1	23	64
		QSCWS2370NSCP	367	1	23	70
		QSCWS2946NSCP	301	1	29	46
		QSCWS2952NSCP	330	1	29	52
		QSCWS2958NSCP	354	1	29	58
		QSCWS2964NSCP	366	1	29	64
		QSCWS2970NSCP	388	1	29	70

WORKSURFACES

CHCB2 - CORNER BRACKET

- Attaches the corner of any worksurface to a panel connector.
- Priced and shipped in pairs.
- Available in standard Fog (FOG) or Designer White (DWT).
- Cannot be used off modular.
- Can be used when a panel is the same depth as the worksurface in the front and back application.

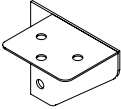
DESCRIPTION	PRODUCT CODE	LIST PRICE	DIMENSIONS/INCHES	
			D	W
 Corner Bracket	QSCHCB2	22	2.5	

CHWB1 - MID SPAN SUPPORT BRACKET

- Does not need to be on module.
- Used when a panel exceeds the depth of the adjacent worksurface.
- Can only be used with a Segmented Panel.
- Comes in unfinished zinc.

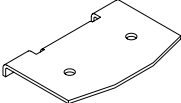
DESCRIPTION	PRODUCT CODE	LIST PRICE	DIMENSIONS/INCHES	
			D	W
 Mid Span Support Bracket	QSCHWB1	14		

CHC15 & CHC22- CANTILEVER

- Attaches a worksurface to a panel.
- Use one cantilever to support two convergent worksurfaces when specified with 3 Flat Brackets or two cantilevers with one flat bracket to support two convergent worksurfaces.
- Does not include Flat Brackets.
- Priced individually
- Specify handedness of each cantilever
- Available in standard Fog (FOG) or Designer White (DWT).
- Right and left Cantilever needs to be specified unless flat brackets are also specified.

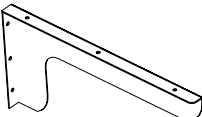
DESCRIPTION	PRODUCT CODE	LIST PRICE	DIMENSIONS/INCHES	
			D	W
 Cantilever - 15"	QSCHC15L	50	15	6
	QSCHC15R	50	15	6
Cantilever - 22"	QSCHC22L	77	22	6
	QSCHC22R	77	22	6

CMHC - WORKSURFACE SUPPORT CHANNEL

- Support channel attaches to underside of worksurface with screws
- Support channel should be 14" shorter than top length.
- Screws are included.
- Only available in Black.
- Tops with post legs should be specified with support channel for structural reinforcement.

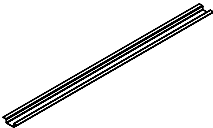
DESCRIPTION	PRODUCT CODE	LIST PRICE	DIMENSIONS/INCHES	
			L	D
 Worksurface Support Channel	QSCMHC40 - for 54" wide table	84	40	5
	QSCMHC46 - for 60" wide table	91	46	5
	QSCMHC52 - for 66" wide table	101	52	5
	QSCMHC58 - for 72" wide table	114	58	5
	QSCMHC64 - for 78" wide table	124	64	5
	QSCMHC70 - for 84" wide table	138	70	5

WORKSURFACES

CHFB1 - FLAT BRACKET

- Use in conjunction with Cantilever to make it a shared Cantilever to support convergent worksurfaces.
- Available in Black only.
- Used at the front of 2 convergent worksurfaces to keep worksurfaces flush at seams.

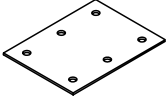
	DESCRIPTION	PRODUCT CODE	LIST PRICE	DIMENSIONS/INCHES	
				D	W
	Flat Bracket	QSCHFB1	21	3	4

CHEP - END PANEL

- Supports the worksurface and enhances the stability of connected panels.
- Provides solid support at the end of a run of worksurfaces.
- Finished in thermally-fused laminate.
- Includes flat brackets and hardware.
- End panel height is inclusive of panel glides extended to their fullest height.
- If wood grains is selected, grain runs vertically.

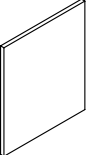
	DESCRIPTION	PRODUCT CODE	LIST PRICE	DIMENSIONS/INCHES	
				D	W
	End Panel - 28"High	QSCHEP2924	264	28	24
		QSCHEP2930	311	28	30

CHMEGR - METAL END GABLE - RIGHT

- Supports the worksurface and enhances the stability of connected panels.
- Available in standard Fog (FOG) or Designer White (DWT).
- Includes a levelling glide and decorative PVC sleeve to cover the glide.

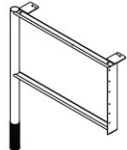
	DESCRIPTION	PRODUCT CODE	LIST PRICE	DIMENSIONS/INCHES		
				H	D	W
	Metal End Gable - Right	QSCHMEG24R	285	28	23	4
		QSCHMEG30R	300	28	29	4

CHMEGL - METAL END GABLE - LEFT

- Supports the worksurface and enhances the stability of connected panels.
- Available in standard Fog (FOG) or Designer White (DWT).
- Includes a levelling glide and decorative PVC sleeve to cover the glide.

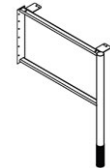
	DESCRIPTION	PRODUCT CODE	LIST PRICE	DIMENSIONS/INCHES		
				H	W	D
	Metal End Gable - Left	QSCHMEG24L	285	28	23	4
		QSCHMEG30L	300	28	29	4



WORKSURFACES

CHMSL - METAL SUPPORT LEG

- Supports two adjoining worksurfaces and enhances the stability of connected panels.
- Includes a levelling glide and decorative PVC sleeve to cover the glide.
- Available in standard Fog (FOG) or Designer White (DWT).
- Flat brackets recommended to ensure alignment of neighboring surface.

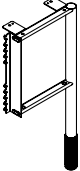
	DESCRIPTION	PRODUCT CODE	LIST PRICE	DIMENSIONS/INCHES		
				H	W	D
	Metal Support Leg	QSCHMSL12	239	28	11	4

CHMSL - MID SUPPORT LEG

- Provides support for a worksurface.
- Includes leveling glide, PVC Sleeve and 4.8" x 4.8" attachment plate.
- 1.5" diameter.
- Available in standard Fog (FOG) or Designer White (DWT).

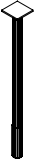
	DESCRIPTION	PRODUCT CODE	LIST PRICE	DIMENSIONS/INCHES
				H
	Mid Support Leg - Round	QSCHMSL1	91	28
	Mid Support Leg - Square	QSCHMSL2	91	28

CMHCL & CHHCL - CORNER LEG WITH LEVELER

- Provides support for a worksurface.
- Includes leveling glide, PVC Sleeve and attachment plate.
- 1.5" diameter
- Available in standard Fog (FOG) or Designer White (DWT).
- Legs can be used in the corner of a single worksurface or be rotated 45 degrees to support the corners of two worksurfaces.

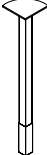
	DESCRIPTION	PRODUCT CODE	LIST PRICE	DIMENSIONS/INCHES
				H
 	Corner Leg Round	QSCMHCL1	127	28
	Corner Leg Square	QSCMHCL2	127	28

WORKSURFACES

CHWS - 5" SURFACE TO STORAGE SUPPORT LEG

- Provides support for a worksurface.
- Includes leveling glide, PVC Sleeve and 4.8" x 4.8" attachment plate.
- 1.5" diameter.
- Available in standard Fog (FOG) or Designer White (DWT).

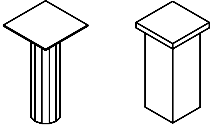
	DESCRIPTION	PRODUCT CODE	LIST PRICE	DIMENSIONS/INCHES H
	5" Surface to Storage Support Leg - Round	QSCHWSRL01	59	4.5
	5" Surface to Storage Support Leg - Square	QSCHWSSL01	59	4.5

PEDESTAL FILLER BRACKET

- Screws to back of pedestal
- Fills the gap between the pedestal and panel when wing panel is not used.
- Available in standard Fog (FOG) or Designer White (DWT).

DESCRIPTION	PRODUCT CODE	LIST PRICE	DIMENSIONS/INCHES D W	
Pedestal Filler Bracket-	QSCHPBF	60	26.875	1.375

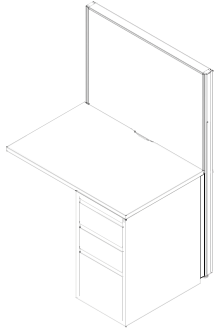

storage